

# Linha Quality<sup>®</sup>



**PEESA<sup>®</sup>**

Tecnologia e Design











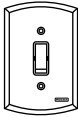

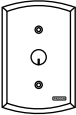
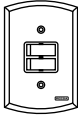
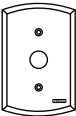

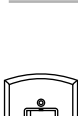

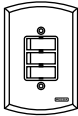
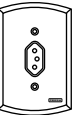
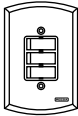
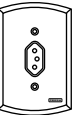



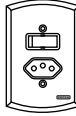
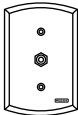

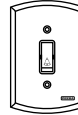

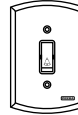
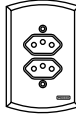
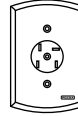

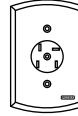
## Linha Quality

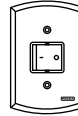

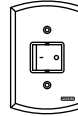
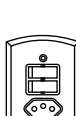
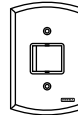

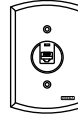











- Design exclusivo
- Beleza e ergonomia
- Superfície lisa sempre limpa
- Tomadas, Interruptores e Pulsadores atendem as normas técnicas INMETRO/ABNT.

























# Conjuntos com Placa

Descrição	Branco	Descrição	Branco
 Interruptor Simples 10A-250V- (20 unid. caixa)	502-A	 Campainha Cigarra 127V- 220V- (10 unid. caixa)	527
 Interruptor Paralelo 10A-250V- (20 unid. caixa)	502-B	 Variador de Luminosidade (Dimmer) Rotativo Bivolt (04 unid. caixa)	528
 2 Interruptores Simples 10A-250V- (20 unid. caixa)	505-A	 Sensor de Presença Bivolt (04 unid. caixa)	531
 2 Interruptores Paralelos 10A-250V- (20 unid. caixa)	505-B	 Controles de Ventilador Bivolt (04 unid. caixa)	532
 1 Interruptor Simples e 1 Interruptor Paralelo 10A-250V- (20 unid. caixa)	505-C	 Controles de Ventilador Bivolt com Interruptor Paralelo (04 unid. caixa)	532-B
 3 Interruptores Simples 10A-250V- (20 unid. caixa)	507-A	 Tomada Padronizada 2P + T 10A-250V- (20 unid. caixa)	541
 3 Interruptores Paralelos 10A-250V- (20 unid. caixa)	507-B	 Tomada Padronizada 2P + T 20A-250V- (20 unid. caixa)	545
 2 Interruptores Simples e 1 Paralelo 10A-250V- (20 unid. caixa)	507-C	 1 Interruptor Simples + 1 Tomada Padronizada 2P + T 10A-250V- (20 unid. caixa)	543A
 1 Interruptor Simples e 2 Paralelos 10A-250V- (20 unid. caixa)	507-D	 1 Interruptor Paralelo + 1 Tomada Padronizada 2P + T 10A-250V- (20 unid. caixa)	543B
 Tomada Conectora TV/Video (20 unid. caixa)	509	 1 Interruptor Simples 10A-250V- + 1 Tomada Padronizada 2P + T 20A-250V- (20 unid. caixa)	546A
 1 Pulsador Campainha 10A-250V- (20 unid. caixa)	512	 1 Interruptor Paralelo 10A-250V- + 1 Tomada Padronizada 2P + T 20A-250V- (20 unid. caixa)	546B
 1 Pulsador Minuteria 10A-250V- (20 unid. caixa)	513	 2 Tomadas Padronizadas 2P + T 10A-250V- (20 unid. caixa)	544
 Tomada Telefone Padrão Telebrás (20 unid. caixa)	514	 2 Tomadas Padronizadas 2P + T 20A-250V- (20 unid. caixa)	547
 Tomada Telefone Padrão Telebrás com RJ1 (20 unid. caixa)1	516	 2 Interruptores Simples + 1 Tomada Padronizada 2P + T 10A-250V- (20 unid. caixa)	548A
 Interruptor Bipolar Simples 10A-250V- (20 unid. caixa)	518	 2 Interruptores Paralelos + 1 Tomada Padronizada 2P + T 10A-250V- (20 unid. caixa)	548B
 Interruptor Bipolar Paralelo 10A-250V- (20 unid. caixa)	521	 1 Interruptor Simples 1 Interruptor Paralelo + 1 Tomada Padronizada 2P + T 10A-250V- (20 unid. caixa)	548C
 Interruptor Intermediário 10A-250V- (20 unid. caixa)	520	 2 Interruptores Simples 10A-250V- + 1 Tomada Padronizada 2P + T 20A-250V- (20 unid. caixa)	549A
 Tomada para Informática RJ45 (10 unid. caixa)	522	 2 Interruptores Paralelos 10A-250V- + 1 Tomada Padronizada 2P + T 20A-250V- (20 unid. caixa)	549B
		 1 Interruptor Simples 1 Interruptor Paralelo 10A-250V- + 1 Tomada Padronizada 2P + T 20A-250V- (20 unid. caixa)	549C

## Placas 4X4

Descrição	 Branco	Descrição	 Branco
 Placa Cega (20 unid. caixa)	P5400	 1 Posto Retangular e 1 Retangular (20 unid. caixa)	P5422
 Placa com Furo Central (20 unid. caixa)	P5409	 1 Posto Retangular e 2 Retangulares (20 unid. caixa)	P5425
 2 Postos Redondos (20 unid. caixa)	P5411	 3 Postos Retangulares e 1 Retangular (20 unid. caixa)	P5432
 1 Posto Redondo e 1 Retangular (20 unid. caixa)	P5412	 3 Postos Retangulares e 3 Retangulares (20 unid. caixa)	P5433
 1 Posto Redondo e 3 Retangulares (20 unid. caixa)	P5413	 2 Postos Retangulares e 3 Retangulares (20 unid. caixa)	P5453
 1 Posto Redondo e 2 Retangulares (20 unid. caixa)	P5415	 2 Postos Retangulares e 2 Retangulares (20 unid. caixa)	P5455
 1 Posto Redondo e 1 Furo (20 unid. caixa)	P5419	 Redonda Cega (20 unid. caixa)	P5500

## Conjuntos sem Placa

Descrição	 Branco	Descrição	 Branco
 Interruptor Simples 10A-250V- (20 unid. caixa)	402-A	 Tomada para Informática RJ45 (04 unid. caixa)	422
 Interruptor Paralelo 10A-250V- (20 unid. caixa)	402-B	 Tomada Padronizada 2P + T 10A-250V- (20 unid. caixa)	441
 2 Interruptores Simples 10A-250V- (20 unid. caixa)	405-A	 Tomada Padronizada 2P + T 20A-250V- (20 unid. caixa)	445
 2 Interruptores Paralelos 10A-250V- (20 unid. caixa)	405-B	 1 Interruptor Simples + 1 Tomada Padronizada 2P + T 10A-250V- (20 unid. caixa)	443A
 1 Interruptor Simples e 1 Interruptor Paralelo 10A-250V- (20 unid. caixa)	405-C	 1 Interruptor Paralelo + 1 Tomada Padronizada 2P + T 10A-250V- (20 unid. caixa)	443B
 3 Interruptores Simples 10A-250V- (20 unid. caixa)	407-A	 1 Interruptor Simples 10A-250V- + 1 Tomada Padronizada 2P + T 20A-250V- (20 unid. caixa)	446A
 3 Interruptores Paralelos 10A-250V- (20 unid. caixa)	407-B	 1 Interruptor Paralelo 10A-250V- + 1 Tomada Padronizada 2P + T 20A-250V- (20 unid. caixa)	446B
 2 Interruptores Simples e 1 Paralelo 10A-250V- (20 unid. caixa)	407-C	 2 Tomadas Padronizadas 2P + T 10A-250V- (20 unid. caixa)	444
 1 Interruptor Simples e 2 Paralelos 10A-250V- (20 unid. caixa)	407-D	 2 Tomadas Padronizadas 2P + T 20A-250V- (20 unid. caixa)	447
 1 Pulsador Campinha 10A-250V- (20 unid. caixa)	412	 2 Interruptores Simples + 1 Tomada Padronizada 2P + T 10A-250V- (20 unid. caixa)	448A
1 Pulsador Minuteria 10A-250V- (20 unid. caixa)	413	2 Interruptores Paralelos + 1 Tomada Padronizada 2P + T 10A-250V- (20 unid. caixa)	448B
Tomada Telefone Padrão Telebrás (20 unid. caixa)	414	1 Interruptor Simples e 1 Interruptor Paralelo + 1 Tomada Padronizada 2P + T 10A-250V- (20 unid. caixa)	448C
Tomada Telefone Padrão Telebrás com RJ11 (20 unid. caixa)	416	2 Interruptores Simples 10A-250V- + 1 Tomada Padronizada 2P + T 20A-250V- (20 unid. caixa)	449A
Interruptor Bipolar Simples 10A-250V- (20 unid. caixa)	418	2 Interruptores Paralelos 10A-250V- + 1 Tomada Padronizada 2P + T 20A-250V- (20 unid. caixa)	449B
Interruptor Bipolar Paralelo 10A-250V- (20 unid. caixa)	421	1 Interruptor Simples e 1 Interruptor Paralelo 10A-250V- + 1 Tomada Padronizada 2P + T 20A-250V- (20 unid. caixa)	449C
Interruptor Intermediário 10A-250V- (20 unid. caixa)	420		

# Características

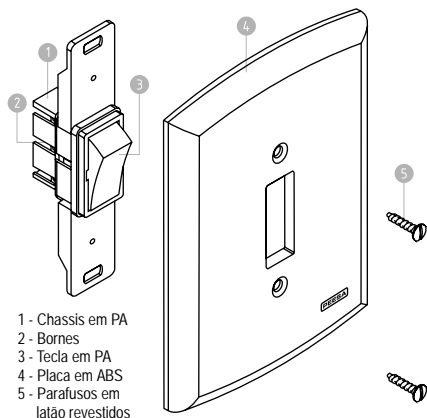



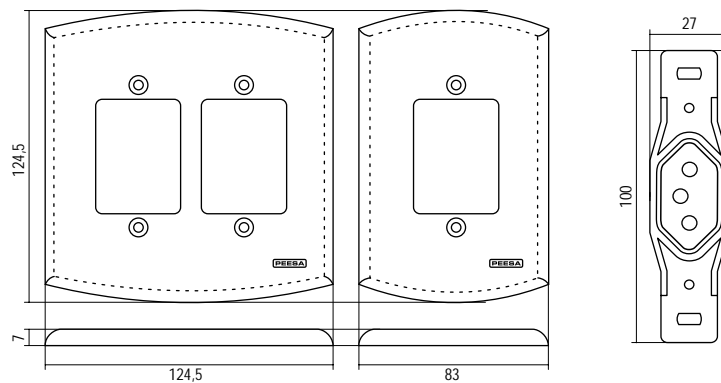









- 1 - Chassis em PA
- 2 - Bornes
- 3 - Tecla em PA
- 4 - Placa em ABS
- 5 - Parafusos em latão revestidos

















Unidade de medidas em "mm"

## Placas 4X2

Descrição	 Branco	Descrição	 Branco
 Placa Cega (50 unid. caixa)	P500	 Placa 1 Tomada Padronizada (50 unid. caixa)	P506
 Placa 1 Posto Redondo (50 unid. caixa)	P501	 Placa 1 Posto Retangular e 1 Tomada Padronizada (50 unid. caixa)	P507
 Placa 1 Posto Retangular (50 unid. caixa)	P502	 Placa 2 Tomadas Padronizadas (50 unid. caixa)	P508
 Placa 3 Postos Retangulares (50 unid. caixa)	P503	 Placa 1 Furo Central (50 unid. caixa)	P509
 Placa 2 Postos Retangulares (50 unid. caixa)	P505	 Placa 2 Postos Retangulares e 1 Tomada Padronizada (50 unid. caixa)	P510

## Placas 4X4

Descrição	 Branco	Descrição	 Branco
 1 Posto Redondo e 1 Padronizado (20 unid. caixa)	P5416	 2 Postos Retangulares e 1 Padronizado (20 unid. caixa)	P5456
 1 Posto Redondo e 2 Padronizados (20 unid. caixa)	P5418	 Placa 2 Postos Retangulares e 2 Padronizados (20 unid. caixa)	P5458
 1 Posto Retangular e 1 Padronizado (20 unid. caixa)	P5426	 2 Postos Padronizados (20 unid. caixa)	P5466
 1 Posto Retangular e 2 Padronizados (20 unid. caixa)	P5428	 1 Posto Padronizados e 1 Furo (20 unid. caixa)	P5469
 Placa 3 Postos Retangulares e 1 Padronizado (20 unid. caixa)	P5436	 4 Postos Padronizados (20 unid. caixa)	P5488
 Placa 3 Postos Retangulares e 2 Padronizados (20 unid. caixa)	P5438	 2 Postos Padronizados e 1 Furo (20 unid. caixa)	P5489



Empresa Certificada



**PEESA®**



0800-150232

[www.peesa.com.br](http://www.peesa.com.br)



Matriz  
Rua Vitor Airoso, 193/195  
Pt. Pequena - CEP 01107-020  
São Paulo - SP

Fábrica  
Av. Nossa Senhora de Fátima, 69  
Centro - CEP 18690-000  
Itatinga - SP

Fones 55 (11) 3313.4455  
55 (11) 3313.4645  
[vendas@peesa.com.br](mailto:vendas@peesa.com.br)

Fone 55 (14) 3848.1500  
[fabrica@peesa.com.br](mailto:fabrica@peesa.com.br)